

22 Halatlı Pasif Tip Ard Germe Grubu 22 Strand Passive Post Tension Group

PG-22

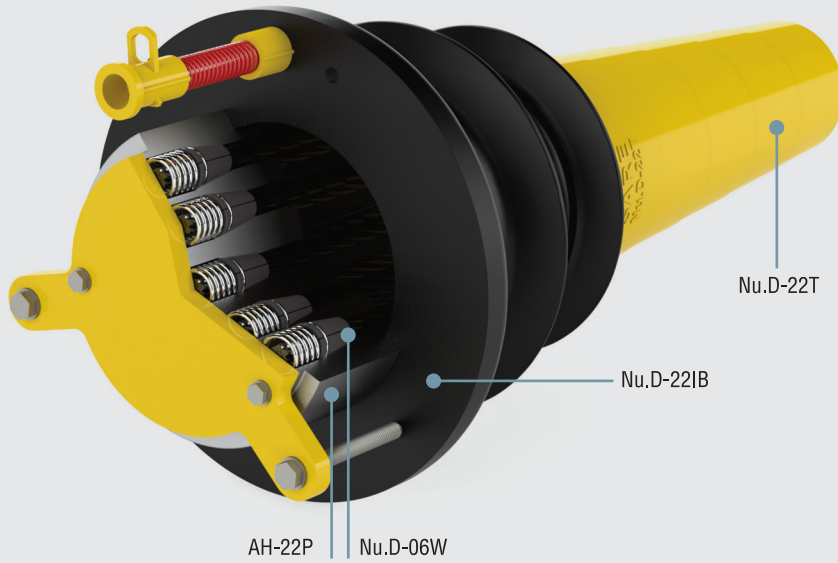

PG-22	Adet / Number	(t) Sayfa / Page
AH-22P	1	33
Nu.D-22IB	1	34
Nu.D-22T	1	35
Nu.D-06W	22	32
Germe Krikosu / Stressing Jack		(t) Sayfa / Page
SJM-580 / 330		37
Galvaniz Boru / Galvanized Corrugated Duct		(t) Sayfa / Page
GSP-22		38
Grup Kapasitesi / Group Capacity		
0.5"		5060 kN
0.6"		6072 kN
0.62"		6270 kN

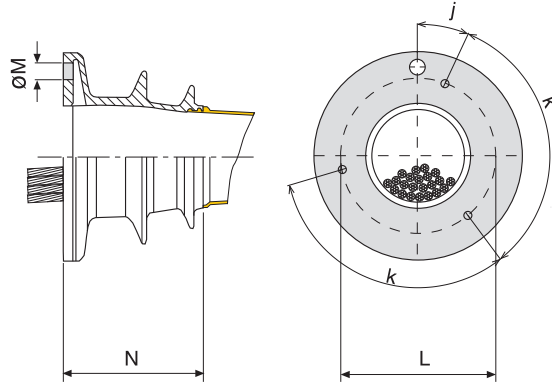

Model No.	J	K	L	M	N
	Ø (mm)	Ø (mm)	Ø (mm)	Ø (mm)	mm
Nu.D-22IB	20°	120°	290	G 1"	243

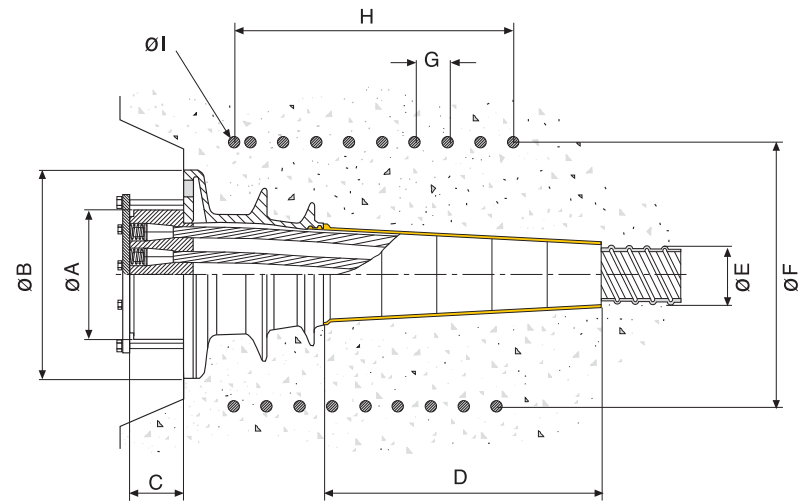

Model No.	A	B	C	D	E	F	G	H	I
	Ø (mm)	Ø (mm)	mm	mm	Ø (mm)	Ø (mm)	mm	mm	Ø (mm)
PG-22	228	344	96	414	110	430	70	560	16