

# PG-7

## 7 Halatlı Pasif Tip Ard Germe Grubu 7 Strand Passive Post Tension Group

PG-7	Adet / Number	(i) Sayfa / Page
AH-7P	1	33
Nu.D-7IB	1	34
Nu.D-7T	1	35
Nu.D-06W	7	32
<b>Germe Krikosu / Stressing Jack</b> (i) Sayfa / Page		
SJM-240 / 300		37
<b>Galvaniz Boru / Galvanized Corrugated Duct</b> (i) Sayfa / Page		
GSP-7		38
<b>Grup Kapasitesi / Group Capacity</b>		
0.5"		1610 kN
0.6"		1932 kN
0.62"		1995 kN

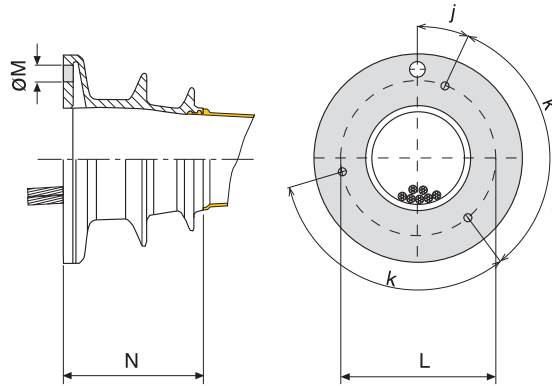
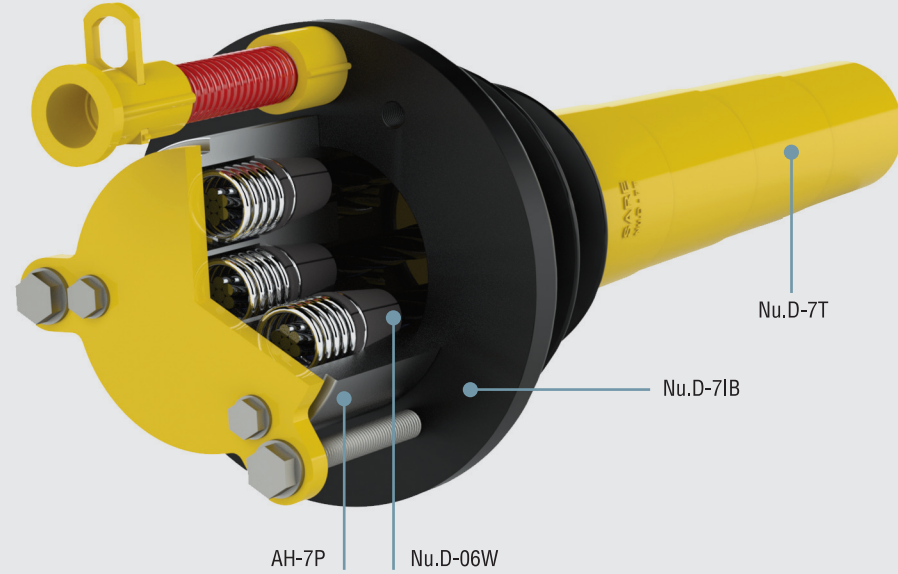

Model No.	J	K	L	M	N
	∅ (mm)	∅ (mm)	∅ (mm)	∅ (mm)	mm
Nu.D-7IB	30°	120°	145	G 3/4"	131

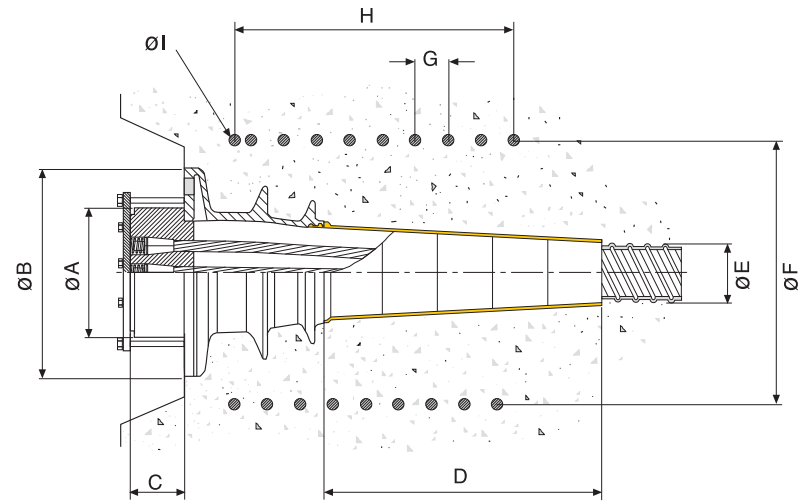

Model No.	A	B	C	D	E	F	G	H	I
	∅ (mm)	∅ (mm)	mm	mm	∅ (mm)	∅ (mm)	mm	mm	∅ (mm)
PG-7	124	200	80	334	63	220	60	360	12