

SJM SERIES
MULTI STRAND
JACK SYSTEMS

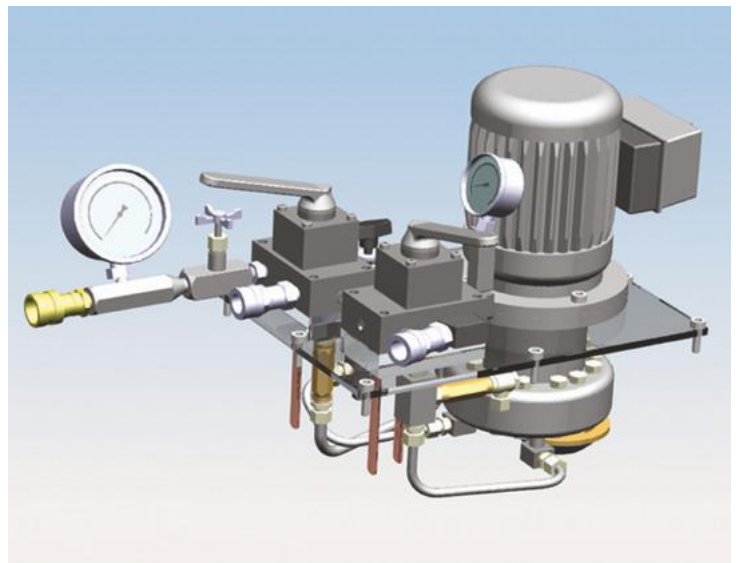
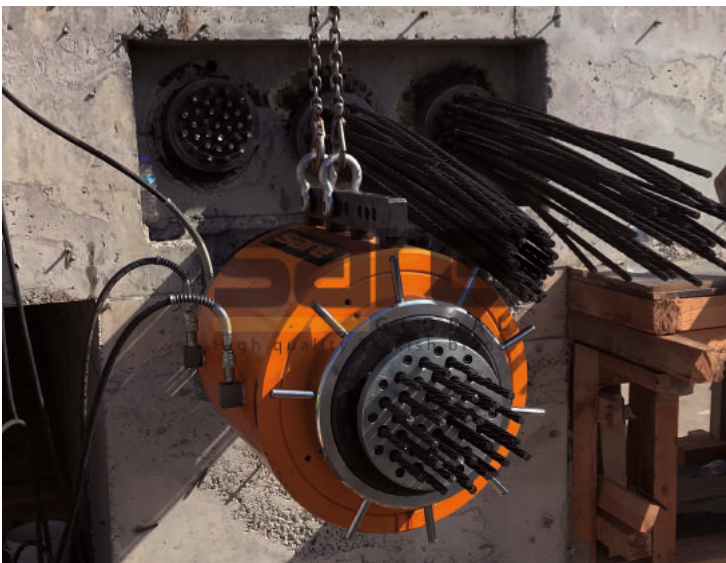

sare[®]
GLOBAL
High quality Turkish brand

DATA SHEET

9 STRAND
MULTI
JACK SET
TECHNICAL
DETAILS

EC DECLARATION OF CONFORMITY

AT UYGUNLUK BEYANI

Manufacturer name

Üretici adı

**SARE MAKİNA YAPI ÜRÜNLERİ İNŞAAT TÜKETİM
MALLARI TAAHHÜT SANAYİ VE TİCARET LİMİTED
ŞİRKETİ**

Manufacturer address

Üretici adresi

**Merkez Mah. Çavuşbaşı Cad. No:42/5 Çekmeköy
İstanbul Turkey**

**herewith declare that the product described below is in conformity with the provisions of
the following essential requirements of EC Directives and standarts when installed in
accordance with the installation instructions contained in the product documentation**

*Aşağıda tarifi yapılan ürünümüz aşağıda belirtilen Avrupa Topluluğu (AT) tarafından yayınlanmış olan
ilgili Avrupa Topluluğu (AT) direktiflerinin ve standartlarının temel sağlık ve güvenlik gerekliliklerini
karşıladığını beyan ederiz*

Product specification

Ürün tanımlaması

**Double Acting, Hydraulic Return,
Multi Strand Stressing Hydraulic**
*Çift tesirli yüksek tonajlı, hidrolik dönüşlü
çoklu halat gerdirme silindiri*

Series, Model(s)

Seriler, Modeller

**SJM Series / 60 – 1000 Ton Capacity ,
30-500 mm Stroke range**
*SJM Serisi / 60 – 1000 Ton Kapasite,
30-500 mm Strok aralığında*

European directive(s)

İlgili AT direktifleri

Machinery Directive (2006/42/EC)

Makine Emniyeti Yönetmeliği (2006/42/AT)

European standart(s)

İlgili AT standartları

EN ISO 4413:2010

EN ISO 12100:2010

**Authorised person to compile the
relevant technical documentation**

*Teknik dosyayı hazırlamakta yetkili
olan ve Türkiye’de yerleşik kişinin adı
ve adresi*

ERSİN UYANIK

**Merkez Mah. Çavuşbaşı Cad. No:42/5 Çekmeköy
İstanbul Turkey**

**For and on behalf of the SARE MAKİNA YAPI ÜRÜNLERİ İNŞAAT TÜKETİM MALLARI TAAHHÜT
SANAYİ VE TİCARET LİMİTED ŞİRKETİ;**

*SARE MAKİNA YAPI ÜRÜNLERİ İNŞAAT TÜKETİM MALLARI TAAHHÜT SANAYİ VE TİCARET LİMİTED ŞİRKETİ
adına;*

Signature

İmza

CE

Name, Function (İsim, Görevi): ERSİN UYANIK, General Manager (Genel Müdür)

Place of issue (Yayınlanma yeri): İstanbul / Turkey

Date of issue (Yayınlanma tarihi): 1.03.2021

SYSTEM SHEMA

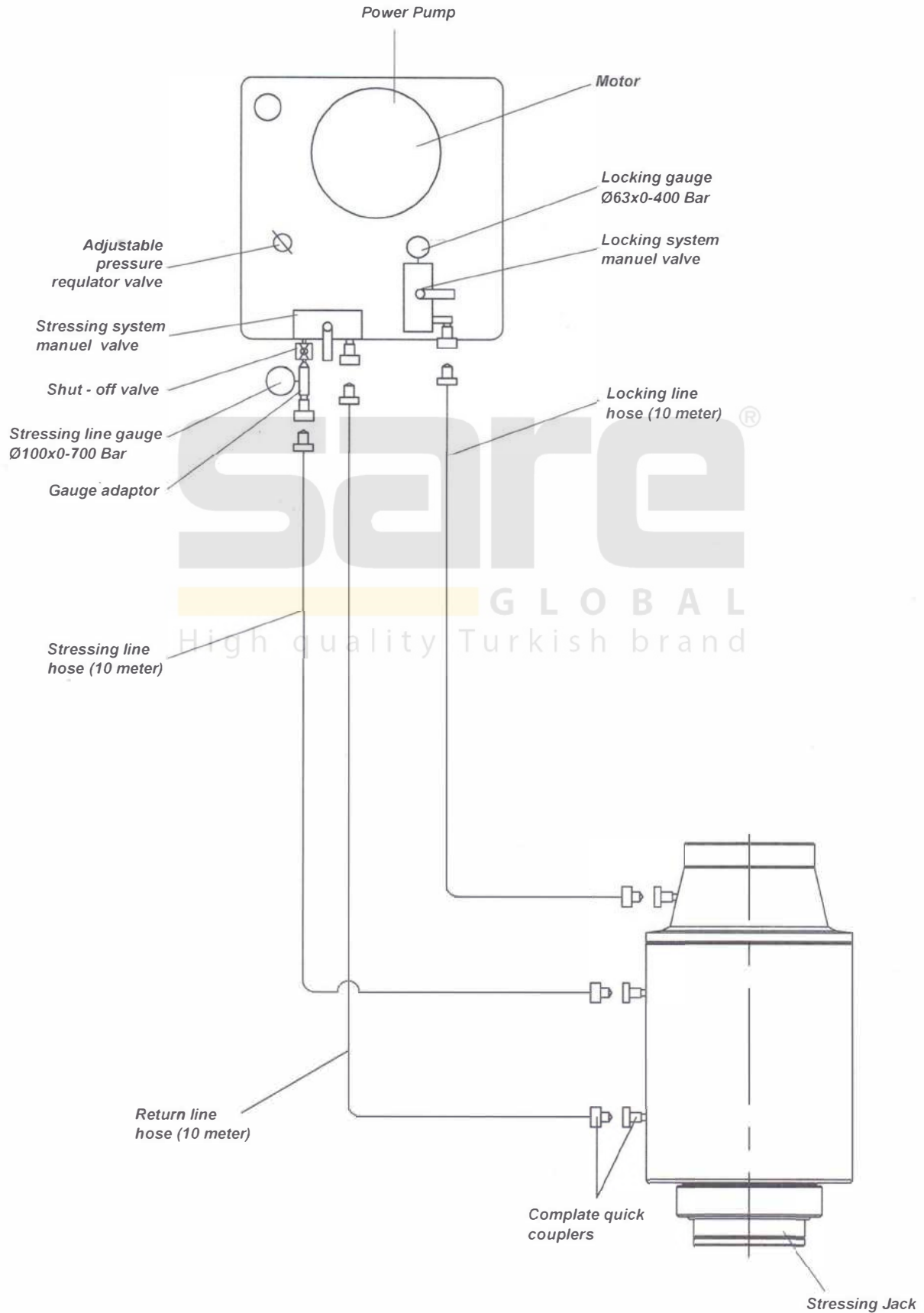

Model No: SJM - 23533 (9 Strand)
235 Ton Capacity Multi Strand Stressing Jack
Data Sheet

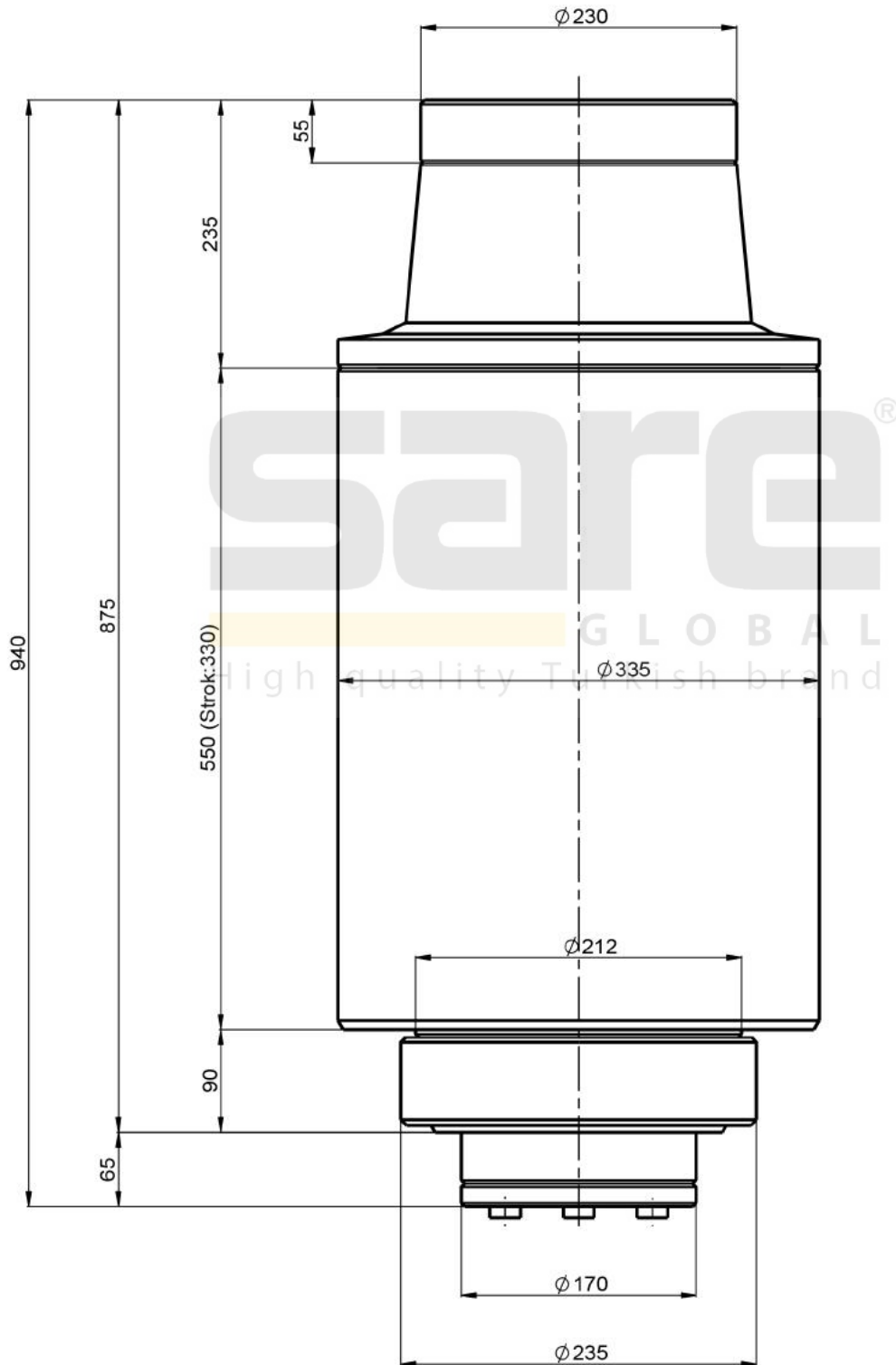

Hydraulic Jack Data Sheet	
item	data
Product	Hydraulic multi strand stressing jack
Type	Multi strand stressing jack with locking system
Model no	SJM-23533
Capacity	235 ton
Number of stressing strand	0,6" x 9 strand
Strok	330 mm
Closed height	940 mm
Cylinder outside diameter	345 mm
Center hole diameter	137 mm
Rod diameter	212 mm
Cylinder inside diameter	265 mm
Cylinder effective area	337,72 cm ²
Oil Capacity	11.144 cm ³
Locking capacity	18 ton
Cylinder ports	3/8" NPT
Working pressure(maximum)	700 bar
Test pressure	800 bar
Weight	306 kg

Model No: EPMS - 257 Hydraulic Electric
Power Pack Data Sheet

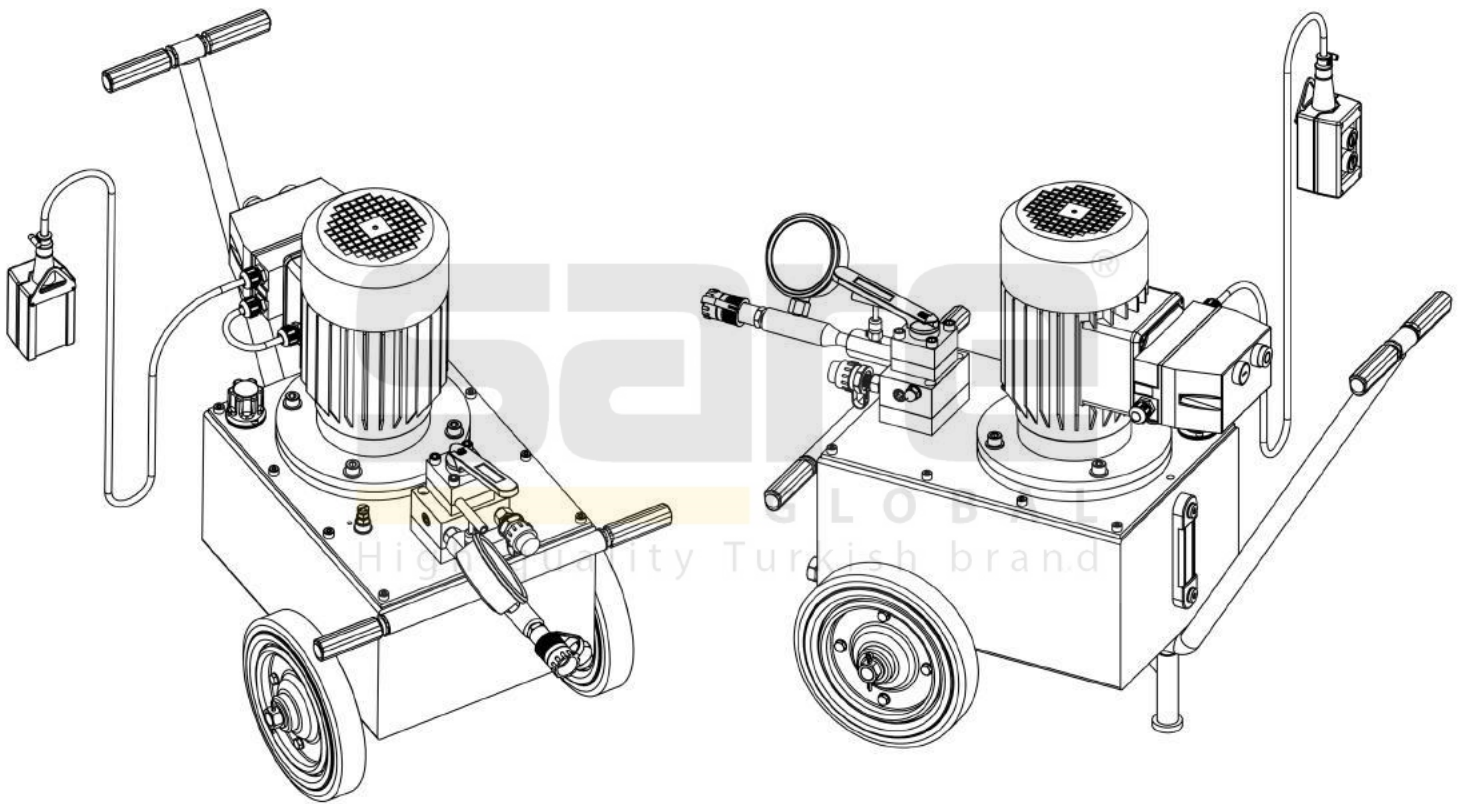

Powerpack Data Sheet	
item	data
Product name	Hydraulic electric power pack
Type	For Multi strand stressing jack with locking system
Model no	EPMS-257
Maximum operating pressure	700 bar
Displacement	2,5 liter/minute
Motor Power	3,0 Kw
Motor rpm	1400
Tank capacity	32 liter
Usable oil capacity	25 liter
Tank size	330 x 450 x 230 (mm)
Pressure Gauge (stressing line)	100 mm x 0-1000 bar (gliserin filled)
Pressure Gauge (locking line)	63 mm x 0-250 bar (gliserin filled)
Locking line pressure	200 bar
Return line pressure	160 bar
Directional control valve (stressing)	4 way-3 position manuel type
Directional control valve (locking)	3 way-3 position manuel type
Valve positions	advance - hold - retract
Valve ports	3/8" NPT
Adjustable pressure regulator valve	20-700 bar capacity, adjustable type
Motor specifications	380 V., 50 Hz., 3 phase
Motor remote control	Start - stop (with 3 meter cord)
Hoses	10 meter long (3pcs)
Weight (full)	98 kg