

9 Halatlı Aktif Tip Ard Germe Grubu 9 Strand Active Post Tension Group

AG-9

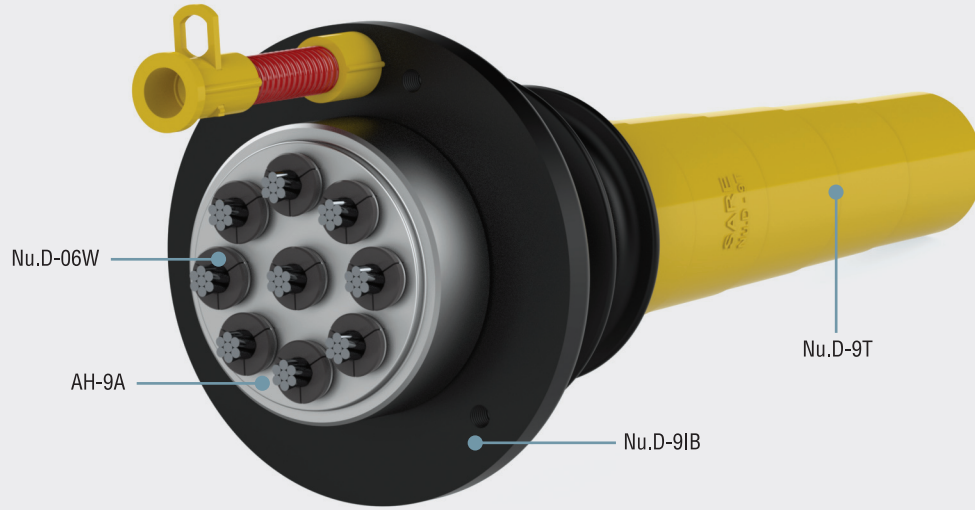

AG-9	Adet / Number	(t) Sayfa / Page
AH-9A	1	33
Nu.D-9IB	1	34
Nu.D-9T	1	35
Nu.D-06W	9	32
Germe Krikosu / Stressing Jack		(t) Sayfa / Page
SJM-240 / 300		37
Galvaniz Boru / Galvanized Corrugated Duct		(t) Sayfa / Page
GSP-9		38
Grup Kapasitesi / Group Capacity		
0.5"		2070 kN
0.6"		2484 kN
0.62"		2565 kN

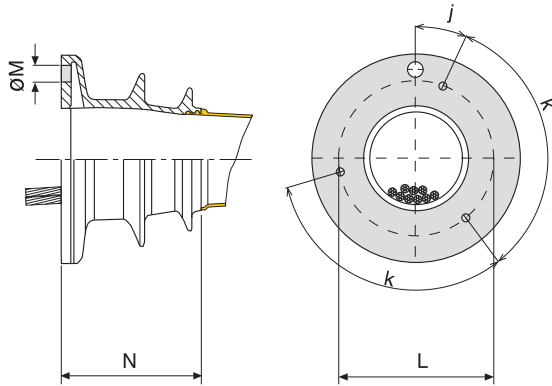

Model No.	J	K	L	M	N
	Ø (mm)	Ø (mm)	Ø (mm)	Ø (mm)	mm
Nu.D-9IB	20°	120°	190	G 3/4"	160

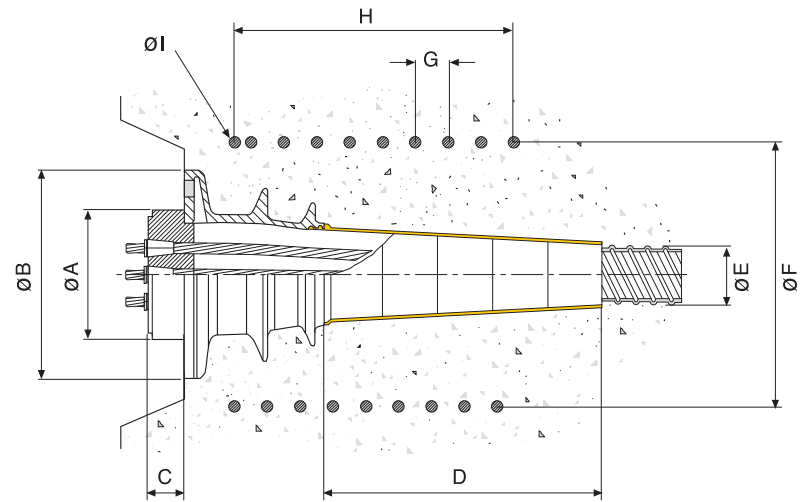

Model No.	A	B	C	D	E	F	G	H	I
	Ø (mm)	Ø (mm)	mm	mm	Ø (mm)	Ø (mm)	mm	mm	Ø (mm)
AG-9	146	235	52	372	70	250	60	360	12